

COVERLAM

5.6mm

Technical Stone



Brought To You By



Lian Hin

COVERLAM

5.6mm

Technical Stone

COVERLAM 5.6MM by GRESPANIA is an innovative product made from natural raw materials with exceptional mechanical & aesthetic properties.

As an international ceramic manufacturing company, GRESPANIA has been producing collections which boast both innovative technical properties as well as innovative cutting-edge designs for the past 40 years.

GRESPANIA has 3 factories that are equipped with state-of-the-art technology and one of them uses lamination pressing technology to produce large format slabs that are available in 1200x2600mm and 5.6mm thicknesses.

COVERLAM 5.6MM is highly suitable for use as feature wall, kitchen wall, bay window, coffee tabletop, dresser top and TV console.

COVERLAM 5.6MM can meet the most demanding needs of residential and commercial settings in terms of resistance to heat, chemicals and damp stains. In addition, thanks to its minimal porosity, it is a hygienic and antibacterial surface that is ideal for food preparation.

Innovative and contemporary, **COVERLAM 5.6MM** is perfect for both indoor and outdoor spaces.

COVERLAM

5.6mm

Technical Stone

Advantages



Lightweight



Durable &
Scratch
Resistance



Waterproof
Surface



Frost
Resistance



Impact
Resistance

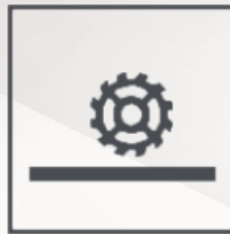

Wear
Resistance



Stain
Resistance



Heat
Resistance



Environmental
Friendly



Flexural Strength



Chemical
Resistance



UV Resistance

Marble Effect

COVERLAM 5.6mm

Ankara Bronze



Artic Gris

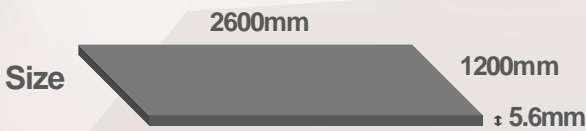

Finishing



Marble Effect

COVERLAM 5.6mm

Calacata Gold



Corinto



Size

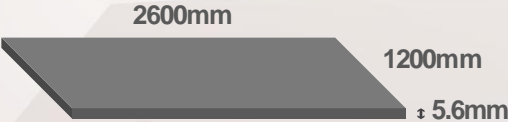

Finishing



Polished

Marble Effect

COVERLAM 5.6mm

Cuarzo Reno



Imperial Ambar

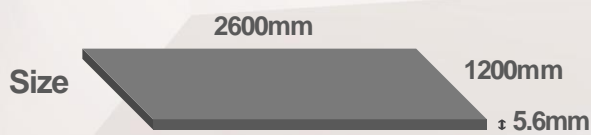

Finishing



Polished

Marble Effect

COVERLAM 5.6mm

Marquina

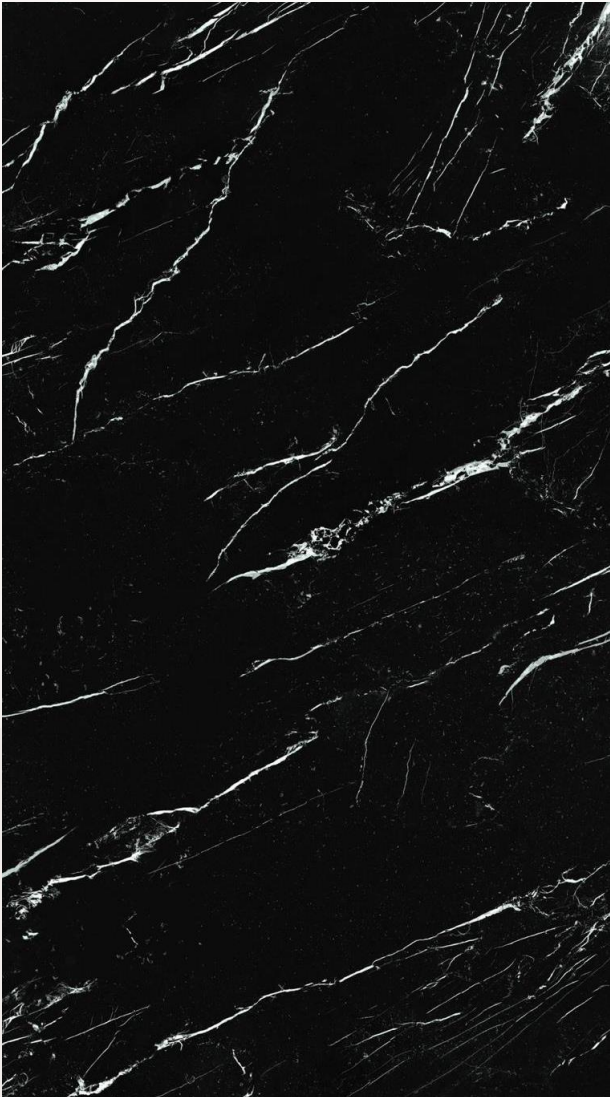

Palisandro



Size

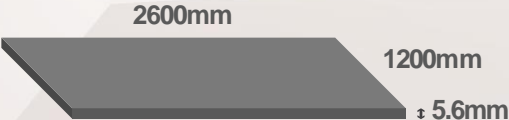

Finishing



Polished

Marble Effect

COVERLAM 5.6mm

Saint Denis



Silk Beige

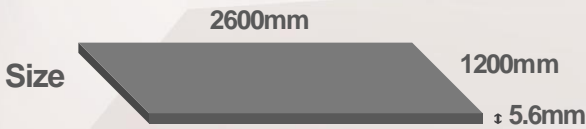

Finishing



Marble Effect

COVERLAM 5.6mm

Tivoli Bianco



Please note that all samples shown in this e-brochure might vary from the actual product due to screen settings and resolution. It is recommended that customers visit our showroom to reconfirm the colour, design and surface finishes at the time of purchase.

Size

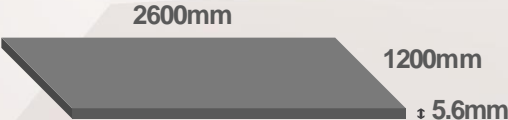

Finishing



Polished

Technical Stone

Profile Types



Flat Polish



Mitre-Joint

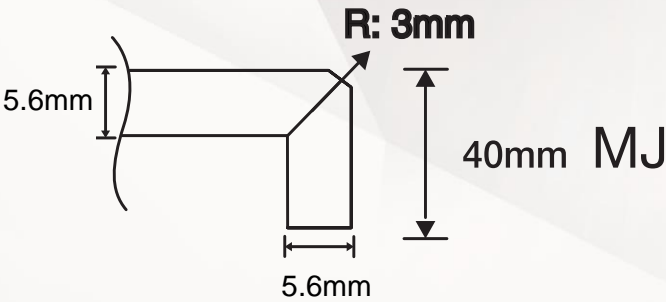

COVERLAM

5.6mm

Technical Stone

Certificates - NSF Certified and Environmental Sustainability Approved Material



**COVERLAM MATERIAL IS
SUITABLE FOR FOOD CONTACT
AND DOES NOT POSE A RISK TO
PUBLIC HEALTH.
(COMPLY WITH NSF/ANSI 51)**



**ENVIRONMENTAL PRODUCT
DECLARATION
(COMPLY WITH EN 14411:2016)**

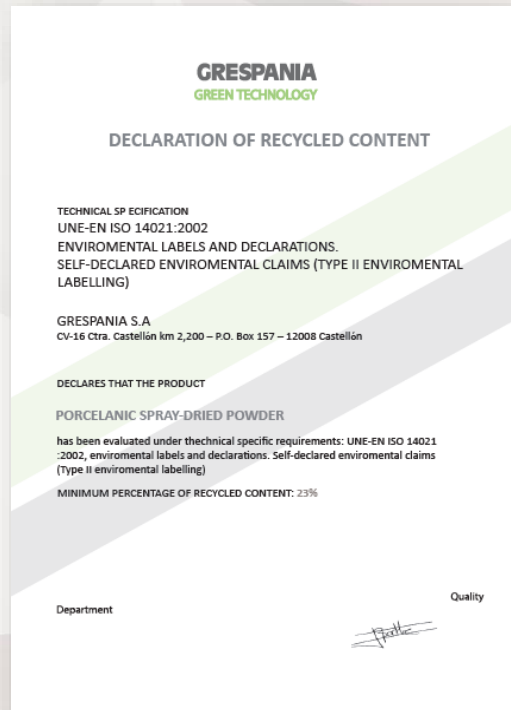

**DECLARATION OF RECYCLED
CONTENT
(COMPLY WITH ISO 14021:2002)**



Lian Hin is the leading expert in multi-faceted surfaces like Granite, Marble, Quartz and Sintered Surface in Singapore.

At **Lian Hin**, we keep it simple. We weave quality aesthetics with practical functionality to create products that last and delight, ranging from feature walls to worktops and vanities.

We deliver our promise through **CANDEO**, **ARCUS**, **MURINNA** and **VULCAN**.



Our Philosophy

Delightful Encounters: Since our establishment, Lian Hin has always valued relationships with our partners and our customers. We create delightful encounters through timely and efficient communication. Our newly minted in-house technology system allows us to track, trace and provide up-to-date information for customers like you, ensuring a seamless experience and peace of mind.

Aesthetic Living: With the fusion of modern engineering and fine craftsmanship, Lian Hin creates products that last. From the source, each slab goes through stringent quality checks before it reaches the hands of our skilled experts. Our commitment to quality extends beyond our strict demands for surface material. We believe in going the extra mile to understand your needs and walk with you every step of the way.

Decision Simplicity: A fuss-free experience is our aim. Choosing a surface should be straightforward, not complicated. Paint your new beginning with Lian Hin's customised offerings. Indulge in our wide range of exquisite products from worktops to feature walls. Leave it to the Lian Hin experts as we cut and design the surfaces you desire.



www.lianhin.com



@lianhinpteltd



@lianhinpl